

litilit

INDYLIT 10

Industrial Femtosecond Laser for Industrial and Medical Applications
1030 nm, 400 fs - 4 ps, 10 W, 70 kHz - 1 MHz

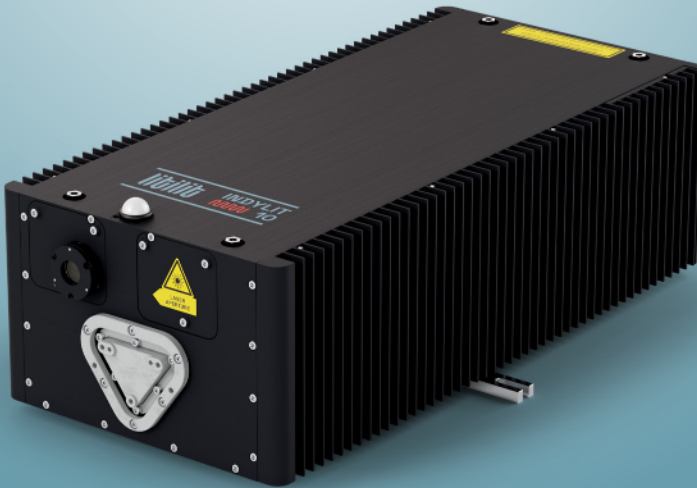

WWW.LITILIT.COM

ROBUST DESIGN FOR FLEXIBLE APPLICATIONS

FEATURES

- Extremely robust and stable
- Adjustable repetition rate, pulse duration, power
- High pulse energy and clean pulse shape
- Passively air cooled
- Maintenance-free & turn-key

APPLICATIONS

- Material microprocessing
- Ophthalmology
- Semiconductor and electronics
- Display manufacturing
- Battery manufacturing
- Stainless steel black and color marking

INDYLIT 10

The **Indylit 10** is a compact, robust, passively air-cooled femtosecond laser designed for industrial and medical applications. The laser emits high-energy (up to 100 μJ) femtosecond pulses with very high temporal contrast. The beam has a Gaussian shape with excellent beam quality and roundness. The laser is dust and water protected (class IP51) and is designed for 24/7 operation in any environment. These properties make the **Indylit 10** a perfect choice for demanding applications where exquisite optical quality and reliable long-term operation are required.

SPECIFICATIONS

Model	Indylit 10
Central wavelength	1030 \pm 2 nm
Average power ¹⁾	> 7W @ 70 kHz > 8 W @ 100 kHz > 10 W @ 1 MHz
Max. pulse energy ¹⁾	> 100 μJ @ 70 kHz > 10 μJ @ 1 MHz
Pulse duration	400 +/- 20 fs
Pulse duration tunability	400 fs - 4 ps
Internal pulse repetition rate	70 kHz – 1 MHz, down to 30 kHz in burst mode
Pulse picker	integrated
Triggering mode	Pulse picker control via TTL gate
Burst length	1...12 pulses
Max. energy in burst	> 300 μJ
Power attenuation ²⁾	100 – 1%
Beam quality	$M^2 < 1.2$
Beam circularity ³⁾	> 0.90
Beam diameter (at 1/e ² level)	2.5 \pm 0.2 mm 5.0 \pm 0.5 mm (optional) 7.5 \pm 0.7 mm (optional)
Polarization	Linear horizontal, > 1000 : 1 extinction
Prepulse contrast	> 1:1000



Model	Indylit 10
Post pulse contrast	> 1:100
Beam divergence (full angle)	< 1 mrad (for 2.5mm beam)
Beam pointing (RMS) ⁴⁾	< 20 μ rad
Beam pointing vs temperature	< 20 μ rad/°C
Power stability (RMS) ⁵⁾	< 1%
Pulse energy stability (RMS) ⁶⁾	< 1%
Warm-up time (cold start)	< 30 min
Warm-up time (warm start)	< 5 min
Laser control interface	CAN, USB
Operating voltage	24V, 25A (100...240 V AC, 47...63 Hz to 24V AC/DC converter included)
Average power consumption (after warm-up)	200 W
Maximal power rating	700 W
Operating temperature	18 – 33 °C ⁷⁾
Humidity	non condensing
Transportation/storage temperature	-20 – +70 °C
Dimensions: Laser head (L x W x H) Control unit (L x W x H) AC/DC converter (L x W x H)	482 x 230 x 163 mm 449 x 385 x 140 mm 250 x 125 x 60 mm
Umbilical length	3 ± 0.1 m
Cooling: Laser head Control unit	air (passive) forced air (fans)

¹⁾ Please refer to the power and energy vs. pulse repetition rate curves for typical values.

²⁾ Attenuation can be controlled by a few different methods: a) by PC user interface, b) by CAN register, c) by analog input (0-1V, rise time <1 μ s). Beam quality specifications are maintained down to 10% power level.

³⁾ Defined as the worst case ellipticity along the z-scan ($\pm 5xL_{Rayleigh}$) of the beam.

⁴⁾ Measured during 8h operation starting 30 minutes after warm-up. Environmental temperature stability within $\pm 1^\circ$ C.

⁵⁾ Measured with integration time of 1s at the same conditions as (6).

⁶⁾ Measured within 10s time interval for at least 1000 pulses.

⁷⁾ Higher operational temperature is available on request. Please contact LITILIT for details.

⁸⁾ Technology is protected by international patents: LT6261 (B); JP6276471 (B2); US10038297 (B2); EP3178137; DK3178137 (T3); CN106575849 (B); PL3178137 (T3); LT6639 (B); LT2020 563

CE RoHS

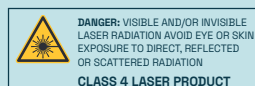

INDYLIT 10

PERFORMANCE

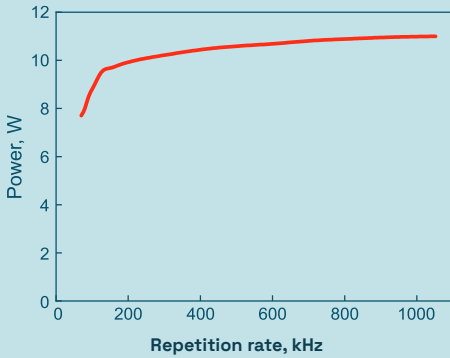

Average power dependence on the pulse repetition rate for infrared

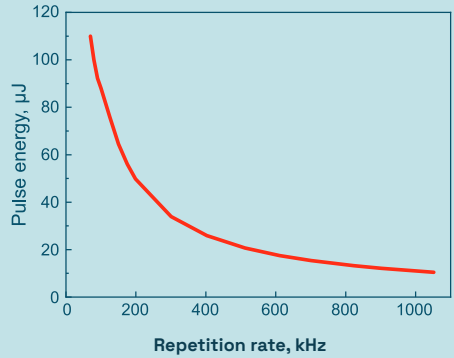

Pulse energy dependence on the pulse repetition rate for infrared

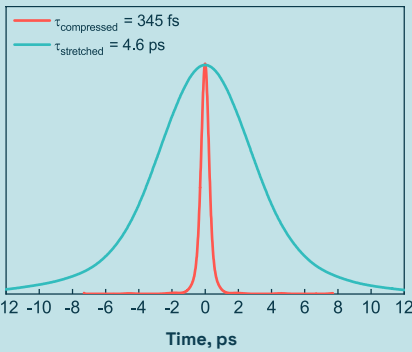

Pulse autocorrelation traces of compressed and maximally stretched 100 μJ pulses

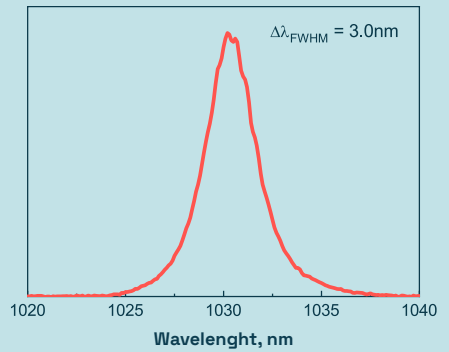

Optical spectrum

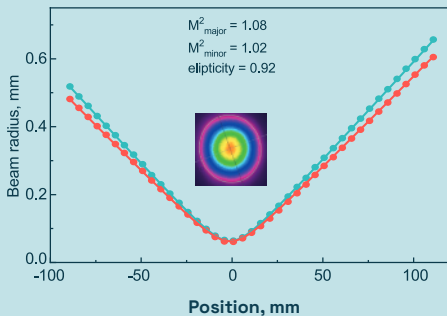

Beam quality measurement and beam profile in far field

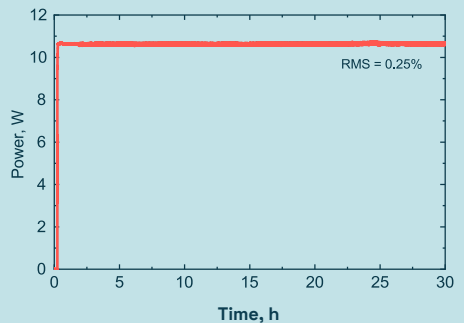

Power stability measurement after cold start

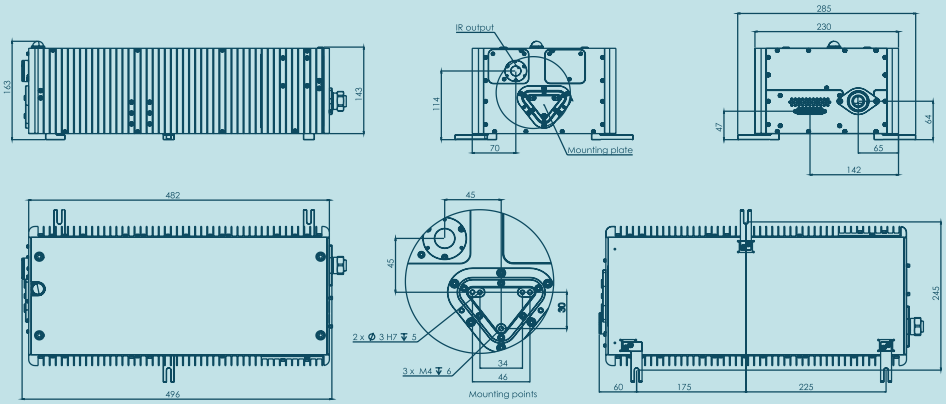

Drawing of Indylit 10 laser head (in mm)

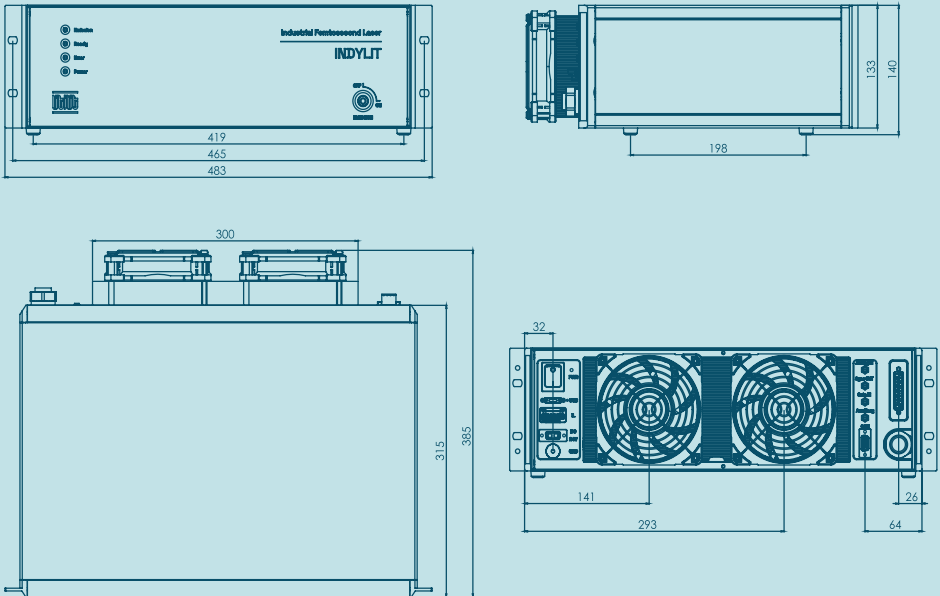

Drawing of Indylit 10 laser control unit (in mm)

